



Ene 2025

Gama Ecolife





Gama EcoLife[®]

Pavimentos para ser vividos naturalmente



eCC life

La gama ECOlife® es el fruto de la apuesta por la innovación de PREFABRICADOS Duero para crear un futuro más sostenible y habitable en nuestras ciudades, que da respuesta a los tres grandes retos medioambientales de nuestros núcleos urbanos:

- Gestionar el agua de lluvia
- Reducir la emisión de gases contaminantes
- Mitigar el efecto "Isla de Calor"



ECOlife[®], pavimentos para ser vividos naturalmente

Innovamos para mitigar el impacto medioambiental en las ciudades aplicando soluciones tecnológicas a nuestros pavimentos capaces de reducir la contaminación del aire y recuperar el agua para nuestros suelos.



Tratamiento fotocatalítico

La gama de pavimentos capaz de descontaminar el aire que respiramos mediante fotocatalisis

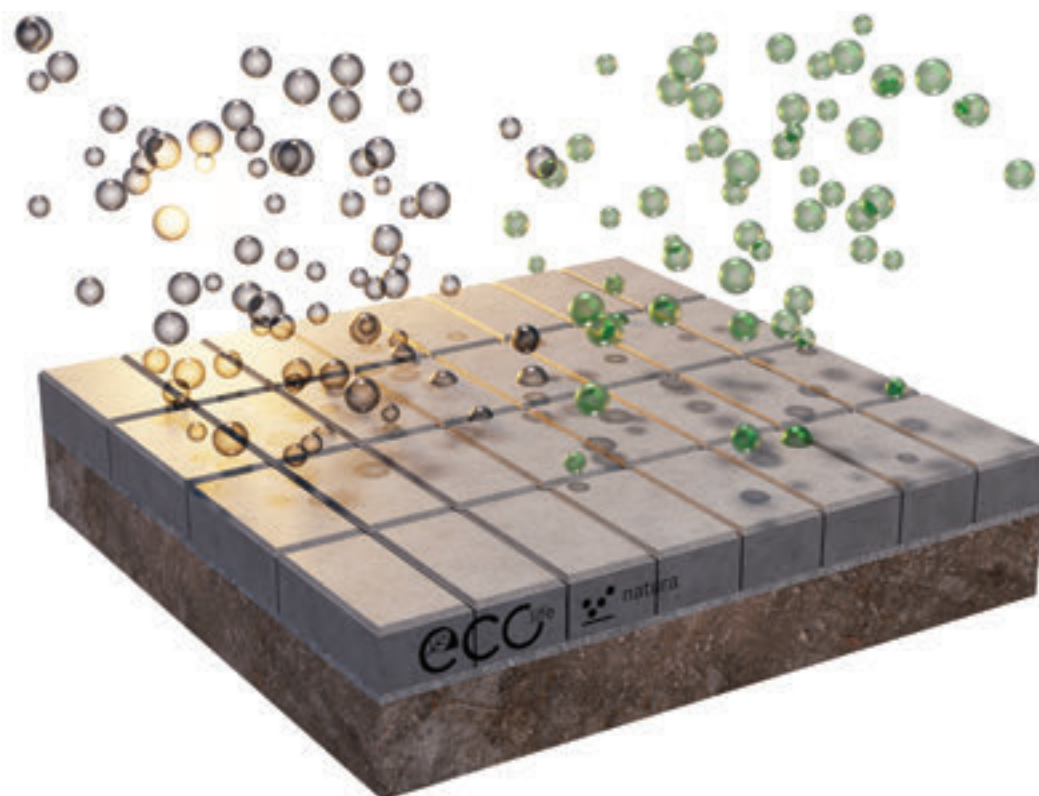

ECOlife[®], pavimentos para ser vividos naturalmente

Innovamos para mitigar el impacto medioambiental en las ciudades aplicando soluciones tecnológicas a nuestros pavimentos capaces de reducir la contaminación del aire y recuperar el agua para nuestros suelos.



Sistema Urbano de Drenaje Sostenible

La gama de pavimentos de hormigón permeables capaz de devolver el agua a su ciclo natural

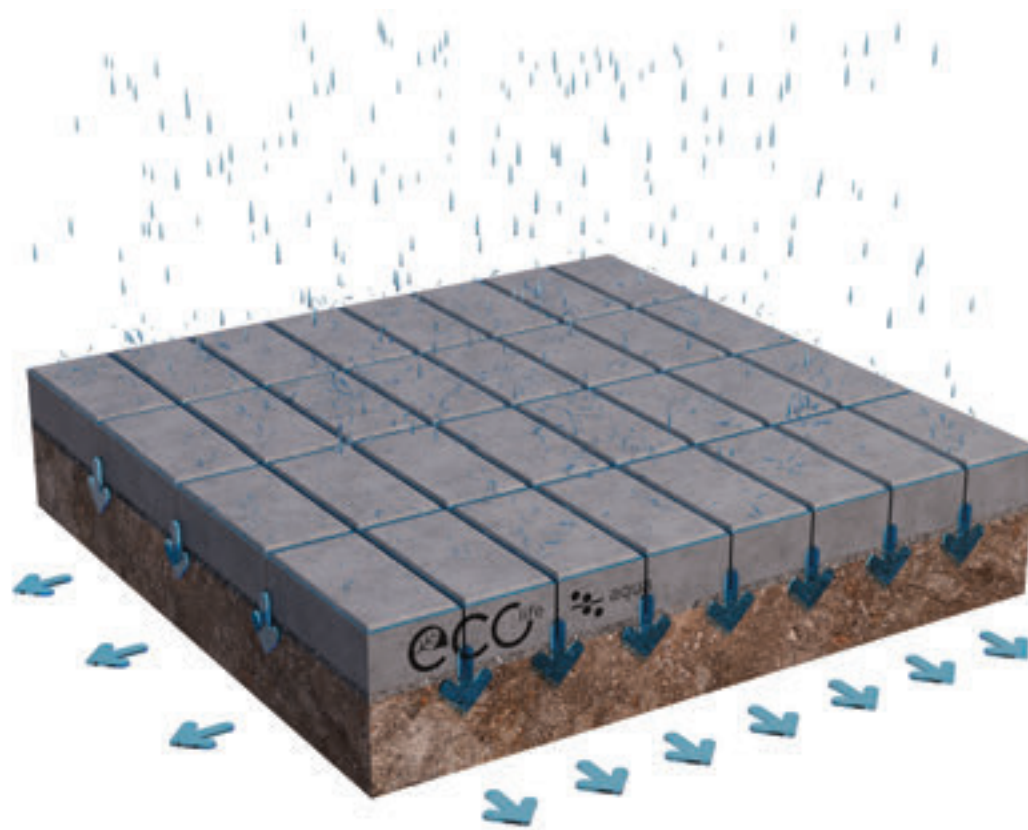



Natura

Global EPD

A VERIFIED ENVIRONMENTAL DECLARATION



Un aire más limpio para nuestras ciudades

La gama de pavimentos capaz de descontaminar el aire que respiramos mediante fotocatalisis



ECOLife® natura

ADOQUINES

Los adoquines de hormigón de Prefabricados Duero destacan por su resistencia a la abrasión y al desgaste, así como por su gran estabilidad, lo que los hace ideales para su uso en espacios exteriores con alto tráfico, como calles, plazas, parques y áreas públicas en general.

Adoquines | natura

10x10 MORALES

Especificaciones técnicas.

Fabricados conforme a la norma **UNE-EN 1338**.

ESPESOR (h)	KG/M ²	M ² /PALET	KG/PALET	ARISTAS
6	140	5	700	45°
8	180	5	900	45°

*Los pesos y medidas son valores orientativos.



Medidas

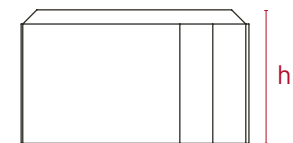
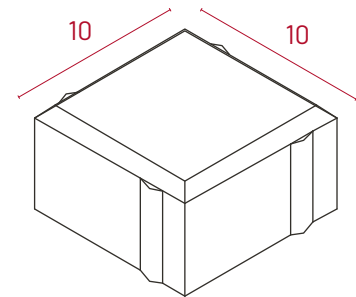

Colores disponibles

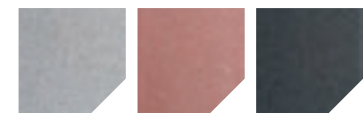

Gris Rojo Negro



Crema Tostado Blanco

Propiedades del producto



Hidrofugado



Bicapa



Sostenible



Ecológico



Adoquines | natura

12x12 ALCAÑICES

Especificaciones técnicas.

Fabricados conforme a la norma **UNE-EN 1338**.

ESPESOR (h)	KG/M ²	M ² /PALET	KG/PALET	ARISTAS
6	140	6,45	930	45° / redonda

*Los pesos y medidas son valores orientativos.



Medidas

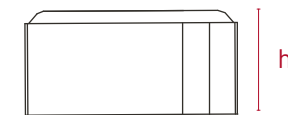
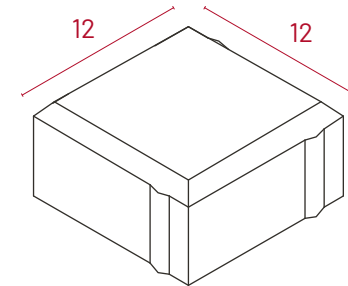

Colores disponibles



Propiedades del producto



Adoquines | natura

20x10 TORO

Especificaciones técnicas.

Fabricados conforme a la norma **UNE-EN 1338**.

ESPESOR (h)	KG/M ²	M ² /PALET	KG/PALET	ARISTAS
6	140	10	1.400	45° / 90°
8	180	10	1.800	45° / 90°
10	220	7	1.585	45° / 90°

*Los pesos y medidas son valores orientativos.



Medidas

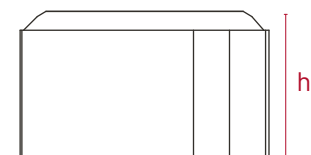
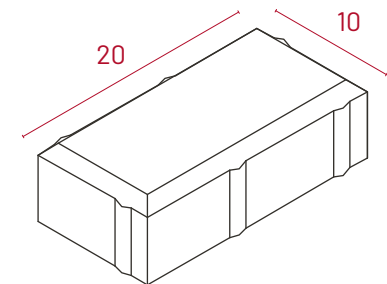

Colores disponibles

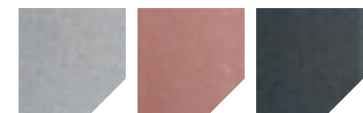

Gris Rojo Negro



Crema Tostado Blanco

Propiedades del producto



Hidrofugado



Bicapa



Sostenible



Ecológico

Disponible en:





Adoquines



24x12 **GUAREÑA**

Especificaciones técnicas.

Fabricados conforme a la norma **UNE-EN 1338**.

ESPESOR (h)	KG/M ²	M ² /PALET	KG/PALET	ARISTAS
6	140	9,22	1.330	45°/ redonda

*Los pesos y medidas son valores orientativos.



Disponible en:



Medidas

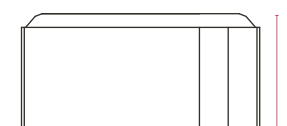
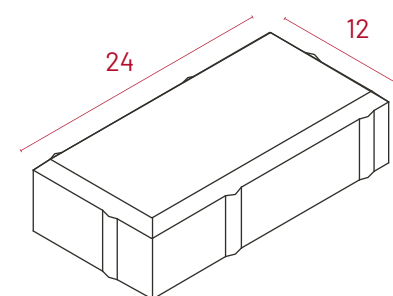

Colores disponibles



Gris Rojo Negro



Crema Tostado Blanco

Propiedades del producto



Hidrofugado



Bicapa



Sostenible



Ecológico





Adoquines | natura

23x12 CORESES

Especificaciones técnicas.

Fabricados conforme a la norma **UNE-EN 1338**.

ESPESOR (h)	KG/M ²	M ² /PALET	KG/PALET	ARISTAS
6	140	9	1.260	45°
8	180	9	1.640	45°

*Los pesos y medidas son valores orientativos.



Medidas

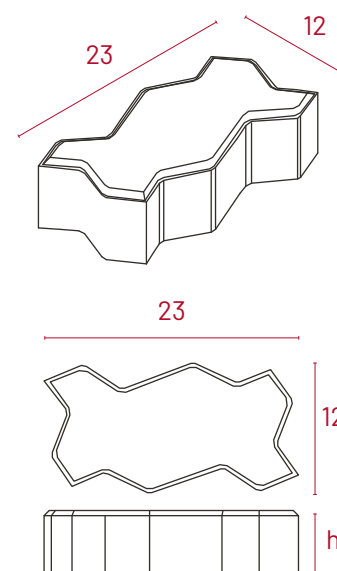

Colores disponibles



Propiedades del producto



Hidrofugado



Bicapa



Sostenible



Ecológico

Adoquines | natura

18-12-9x12 CASTELLANO

Especificaciones técnicas.

Fabricados conforme a la norma **UNE-EN 1338**.

ESPESOR (h)	KG/M ²	M ² /PALET	KG/PALET	ARISTAS
6	140	10	1.400	45°
8	180	10	1.800	45°/ 90°

*Los pesos y medidas son valores orientativos.



Disponible en:



Medidas

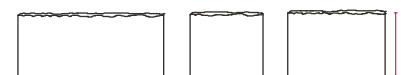
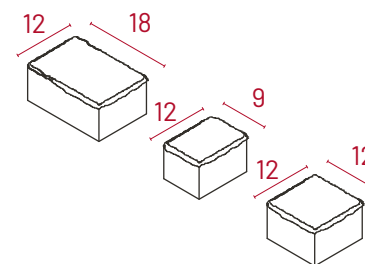

Colores disponibles



Propiedades del producto



Hidrofugado



Bicapa



Sostenible



Ecológico



Adoquines | natura

20x16 BENAVENTE

Especificaciones técnicas.

Fabricados conforme a la norma **UNE-EN 1338**.

ESPESOR (h)	KG/M ²	M ² /PALET	KG/PALET	ARISTAS
8	180	8,6	1.548	45°

*Los pesos y medidas son valores orientativos.



Medidas

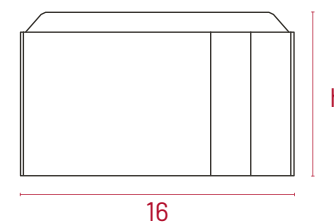
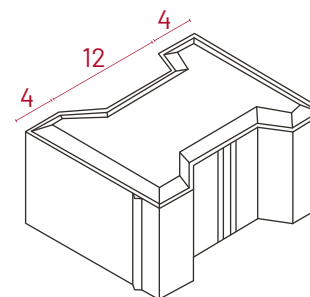

Colores disponibles



Gris Rojo Negro



Crema Tostado Blanco

Propiedades del producto



Hidrofugado



Bicapa



Sostenible



Ecológico





ECOLife® natura

BALDOSAS

Los beneficios del uso de baldosas de hormigón de Prefabricados Duero incluyen su alta resistencia, durabilidad y facilidad de mantenimiento. Además, estas baldosas son resistentes al deslizamiento y ofrecen una excelente tracción en superficies mojadas, lo que las hace ideales para áreas al aire libre, como patios, piscinas, terrazas y caminos de jardín.

Baldosas | natura

20x20 ALISTE

Especificaciones técnicas.

Fabricados conforme a la norma **UNE-EN 1339**.

ESPESOR (h)	KG/M ²	M ² /PALET	KG/PALET	ARISTAS
6	140	10	1.400	45°
8	180	10	1.850	45°/ 90°

*Los pesos y medidas son valores orientativos.



Medidas

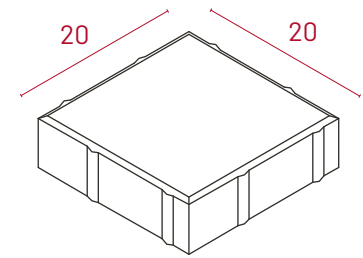

Colores disponibles

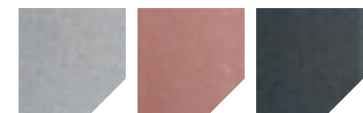

Gris Rojo Negro



Crema Tostado Blanco

Propiedades del producto



Hidrofugado



Bicapa



Sostenible



Ecológico

Disponible en:





Baldosas | natura

30x30 TÁBARA

Especificaciones técnicas.

Fabricados conforme a la norma **UNE-EN 1339**.

ESPESOR (h)	KG/M ²	M ² /PALET	KG/PALET	ARISTAS
6	140	8,1	1.134	45°

*Los pesos y medidas son valores orientativos.

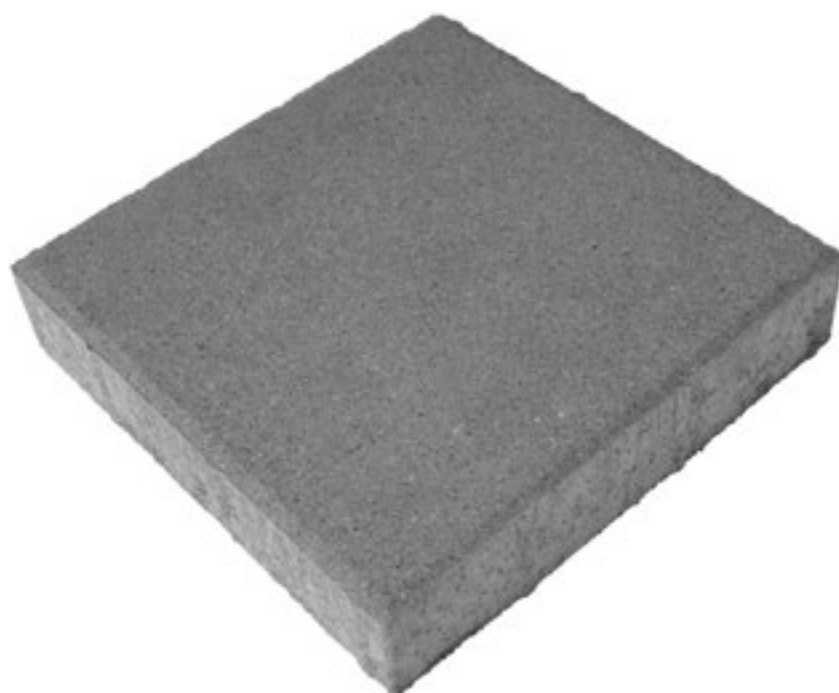

Medidas

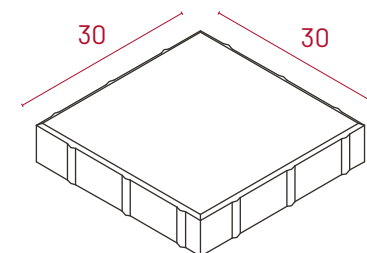

Colores disponibles



Propiedades del producto



Hidrofugado



Bicapa



Sostenible



Ecológico

Baldosas



40x20 COLEGIATA

Especificaciones técnicas.

Fabricados conforme a la norma **UNE-EN 1339**.

ESPESOR (h)	KG/M ²	M ² /PALET	KG/PALET	ARISTAS
6	140	9,6	1.400	45°/90°
8	180	9,6	1.750	90°

*Los pesos y medidas son valores orientativos.



Disponible en:



Medidas

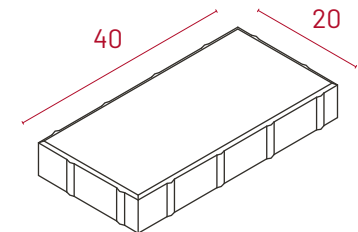

Colores disponibles



Gris Rojo Negro



Crema Tostado Blanco

Propiedades del producto



Hidrofugado



Bicapa



Sostenible



Ecológico



Baldosas



40x40

SAYAGO

Especificaciones técnicas.

Fabricados conforme a la norma **UNE-EN 1339**.

ESPESOR (h)	KG/M ²	M ² /PALET	KG/PALET	ARISTAS
6	140	9,6	1.370	90°

*Los pesos y medidas son valores orientativos.



Medidas

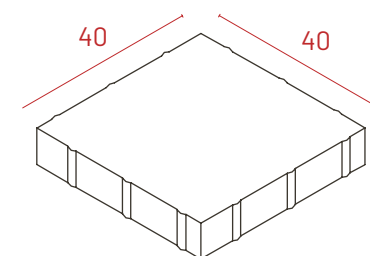

Colores disponibles



Gris Rojo Negro



Crema Tostado Blanco

Propiedades del producto



Hidrofugado



Bicapa



Sostenible



Ecológico

Disponible en:



Baldosas



50x50 TERA

Especificaciones técnicas.

Fabricados conforme a la norma **UNE-EN 1339**.

ESPESOR (h)	KG/M ²	M ² /PALET	KG/PALET	ARISTAS
6	140	10	1.420	90°
8	180	10	1.850	90°

*Los pesos y medidas son valores orientativos.



Disponible en:



Medidas

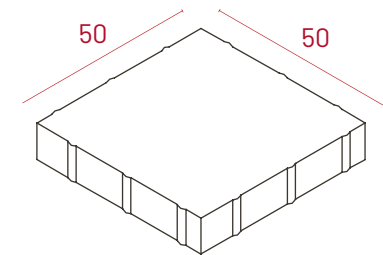

Colores disponibles



Gris Rojo Negro



Crema Tostado Blanco

Propiedades del producto



Hidrofugado



Bicapa



Sostenible



Ecológico



Baldosas | natura

60x40 SANABRIA

Especificaciones técnicas.

Fabricados conforme a la norma **UNE-EN 1339**.

ESPESOR (h)	KG/M ²	M ² /PALET	KG/PALET	ARISTAS
6	140	11,52	1.630	90°
8	180	10,08	1.850	90°

*Los pesos y medidas son valores orientativos.



Medidas

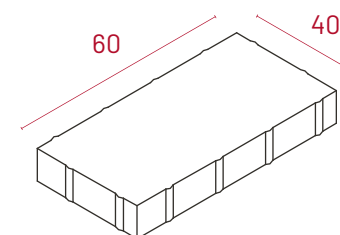

Colores disponibles



Propiedades del producto



Hidrofugado



Bicapa



Sostenible



Ecológico

Disponible en:







Aqua

GlobalEPD

A VERIFIED ENVIRONMENTAL DECLARATION



Sistema Urbano de Drenaje Sostenible

La gama de pavimentos de hormigón permeables capaz de devolver el agua a su ciclo natural

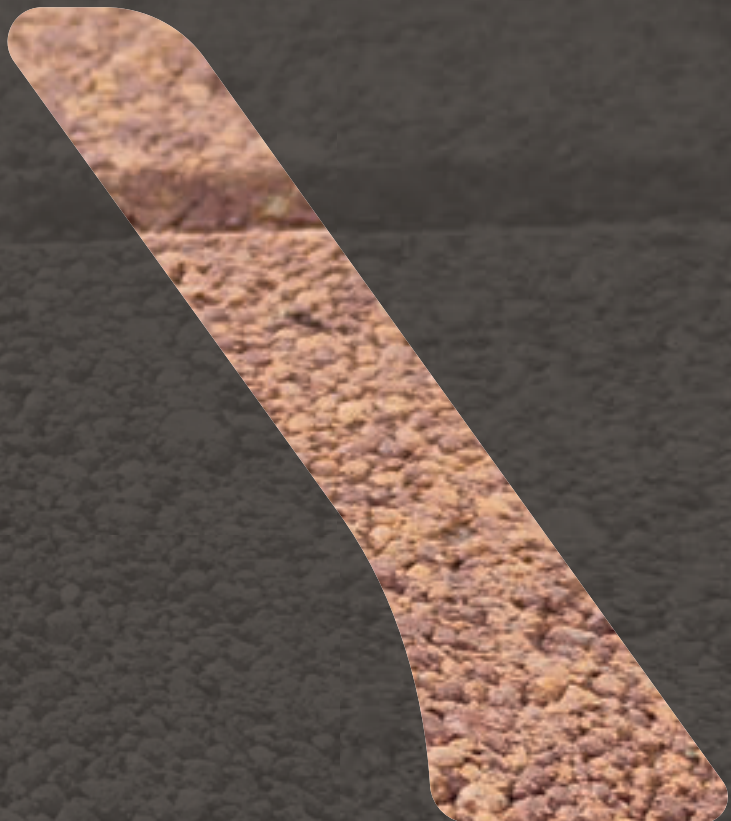
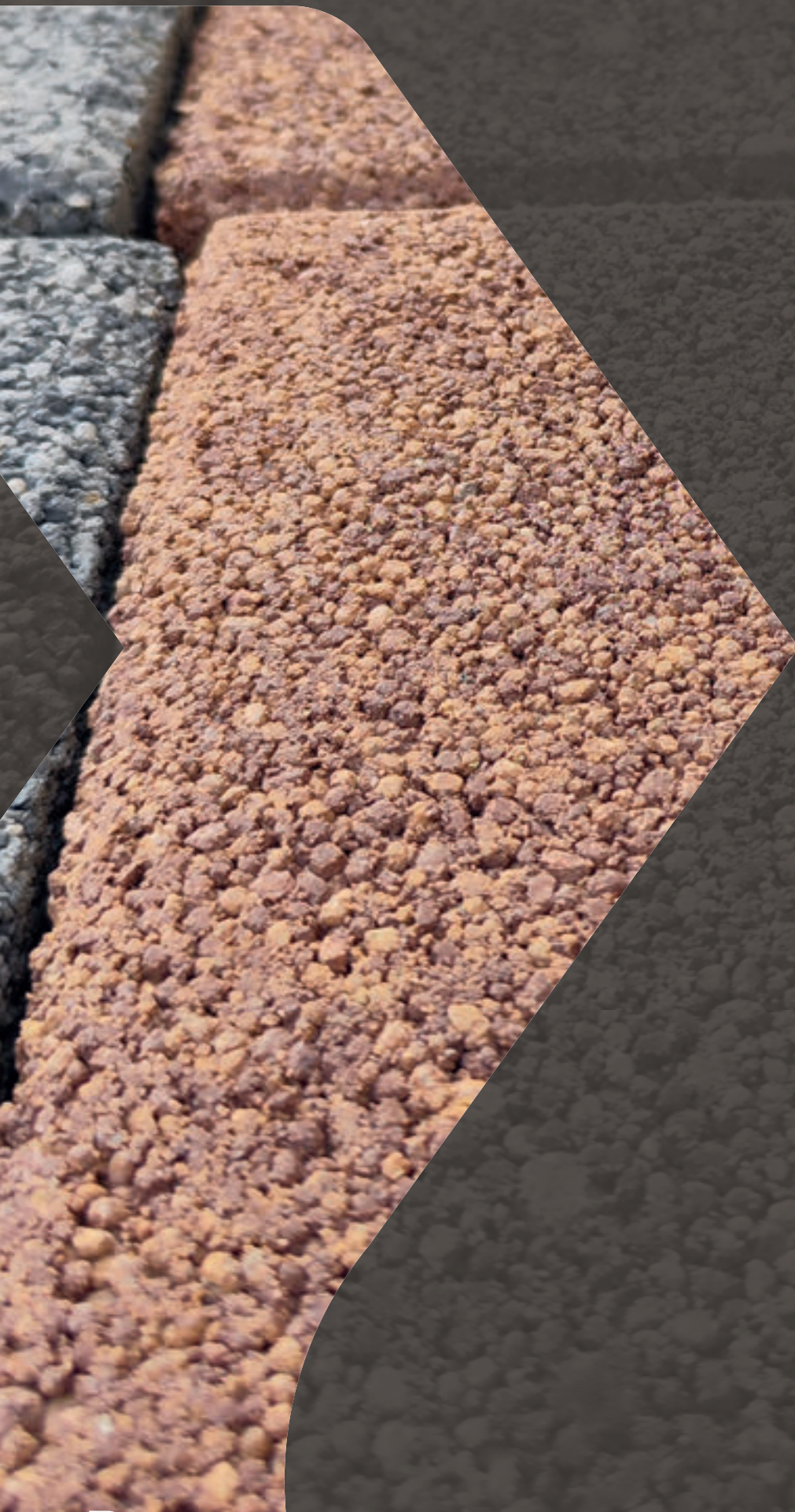

ECOLife® aqua

ADOQUINES

Los adoquines de hormigón de Prefabricados Duero destacan por su resistencia a la abrasión y al desgaste, así como por su gran estabilidad, lo que los hace ideales para su uso en espacios exteriores con alto tráfico, como calles, plazas, parques y áreas públicas en general.

Adoquines | aqua

20x10 TORO

Especificaciones técnicas.

Fabricados conforme a la norma **UNE-EN 1338**.

ESPESOR (h)	KG/M ²	M ² /PALET	KG/PALET	ARISTAS
6	140	10	1.400	45° / 90°
8	180	10	1.800	45° / 90°
10	220	7	1.585	45° / 90°

*Los pesos y medidas son valores orientativos.



Medidas

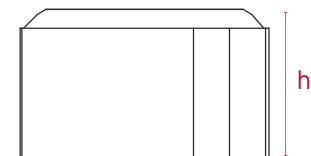
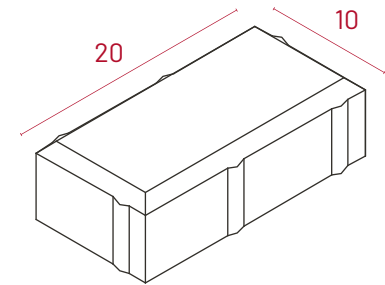

Colores disponibles



Propiedades del producto



Disponible en:





Adoquines



24x12 **GUAREÑA**

Especificaciones técnicas.

Fabricados conforme a la norma **UNE-EN 1338**.

ESPESOR (h)	KG/M ²	M ² /PALET	KG/PALET	ARISTAS
6	140	9,22	1.330	45°/ redonda

*Los pesos y medidas son valores orientativos.



Disponible en:



Medidas

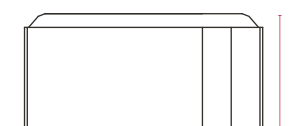
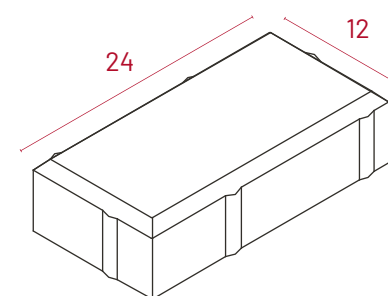

Colores disponibles



Gris Rojo Negro



Crema Tostado Blanco

Propiedades del producto



Hidrofugado



Bicapa



Sostenible



Ecológico





ECOLife® aqua

BALDOSAS

Los beneficios del uso de baldosas de hormigón de Prefabricados Duero incluyen su alta resistencia, durabilidad y facilidad de mantenimiento. Además, estas baldosas son resistentes al deslizamiento y ofrecen una excelente tracción en superficies mojadas, lo que las hace ideales para áreas al aire libre, como patios, piscinas, terrazas y caminos de jardín.

Baldosas | aqua

20x20 ALISTE

Especificaciones técnicas.

Fabricados conforme a la norma **UNE-EN 1339**.

ESPESOR (h)	KG/M ²	M ² /PALET	KG/PALET	ARISTAS
6	140	10	1.400	45°
8	180	10	1.850	45°/ 90°

*Los pesos y medidas son valores orientativos.



Medidas

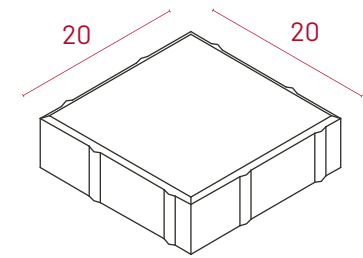

Colores disponibles



Propiedades del producto



Disponible en:





Baldosas | aqua

50x33 CELOSÍA DE CÉSPED

Especificaciones técnicas.

Fabricados conforme a la norma **UNE-EN 1339**.

ESPESOR (h)	KG/M ²	M ² /PALET	KG/PALET	ARISTAS
10	150	6	910	45°

*Los pesos y medidas son valores orientativos.



Medidas

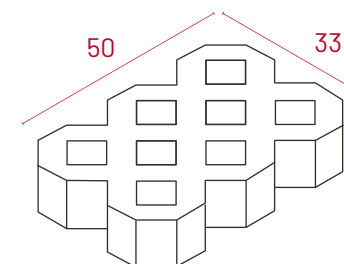

Colores disponibles



Gris

Propiedades del producto



Hidrofugado



Ecológico



Sostenible

Disponible en:







Prefabricados Duero

Ctra. Pozoantiguo, Km. 1, 1, 49800 Toro, Zamora

www.prefabricadosduero.com